



1000 KG
WORKING LOAD LIMIT

ULTRA LOW PROFILE PROFESSIONAL
WORKSHOP JACK

OWNER/USER INSTRUCTION MANUAL

Model SWJ1000ULP trolley jack is a self-contained device designed for lifting, but not sustaining, a partial vehicular load. It consists of a frame with wheels and swivel castors supporting a mechanism that actuates a pivoting lift arm equipped with a saddle. It is designed for use by professional auto mechanics.

SPECIFICATIONS

Lift Capacity:	1,000 kgs
Height Lowered:	70 mm
Height Raised:	610 mm
Saddle Dimensions:	118 mm
Handle Length:	1,270 mm
Dimensions:	965 mm x 425 mm x 190 mm
Weight N.W./G.W.:	49 kgs/51 kgs



Consult the vehicles manufacturer's manual prior to lifting the vehicle. Conduct a pre-operational check of the equipment.

AS 2615:2016

IMPORTANT! BEFORE USING THIS JACK:

The breather located below the hole in cross plate must be opened. Insert slotted screw driver through hole and turn breather screw counter clockwise until it stops turning. Do not force screw past stopping point.

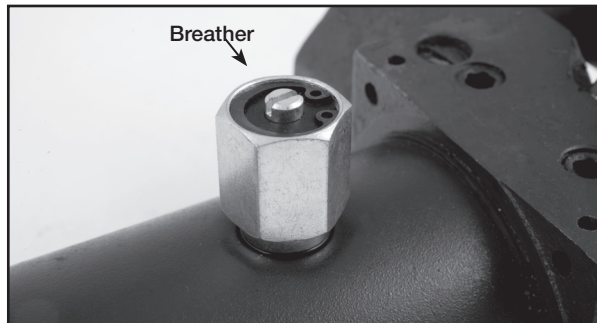

SAVE THIS MANUAL FOR FUTURE REFERENCE



1000 KG
WORKING LOAD LIMIT

ULTRA LOW PROFILE PROFESSIONAL
WORKSHOP JACK

SAFETY WARNINGS MUST READ INSTRUCTIONS BEFORE USE



WARNING

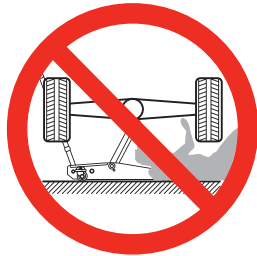

DEATH OR INJURY
FROM INCORRECT USE

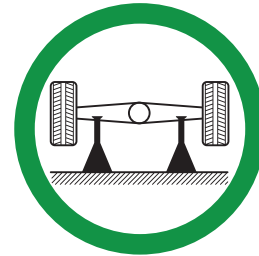

USE TWO
SUPPORT STANDS

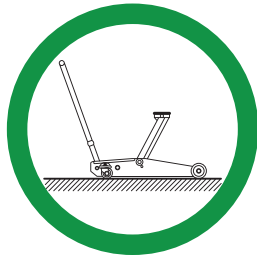

FLAT HARD
LEVEL GROUND

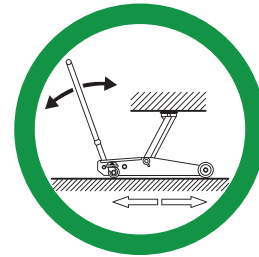

FREE TO ROLL DURING
LIFTING AND LOWERING



- Read, study, understand, & follow all instructions before using.
- Failure to heed these warnings may result in serious or fatal personal injury and/or property damage.
- Inspect the jack before each use. Do not use jack if damaged, altered, modified, in poor condition, leaking hydraulic fluid, or unstable due to loose or missing components. Make corrections before using.
- Do not use jack beyond its rated capacity. Do not shock load.
- **This is a lifting and lowering device only. Immediately after lifting, support the vehicle with two support stands capable of sustaining the load before working on the vehicle.**
- Use only on a hard level surface free from obstructions so the jack is free to reposition itself during lifting and lowering operations.
- Lift only on areas of the vehicle as specified by the vehicle manufacturer.
- Chock the unlifted wheels of the vehicle.
- No person should remain in a vehicle that is being lifted.
- Center load on saddle. Be sure setup is stable before working on vehicle.
- Do not move or dolly the vehicle while on the jack.
- Do not use any materials that may serve as risers, spacers or extenders between the stock lifting saddle and the load.
- Do not use any adaptors that replace the stock lifting saddle unless approved or supplied by the manufacturer.
- Do not use (or modify) this product for any other purpose than that for which it was designed.
- Support the vehicle on suitably rated vehicle support stands and remove the hydraulic trolley jack prior to commencement of work on the vehicle.
- Modifications must not be carried out or accessories added

REFER TO VEHICLE MANUFACTURER'S MANUAL FOR INSTRUCTIONS
SAVE THESE INSTRUCTIONS



Ref	WORKING LOAD LIMIT (kg)	MAX (mm)	MIN (mm)
SWJ1000ULP	1000	610	70

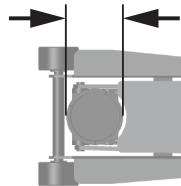

Cap diameter:118mm

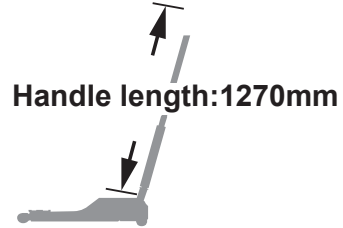

Handle length:1270mm

WARNING

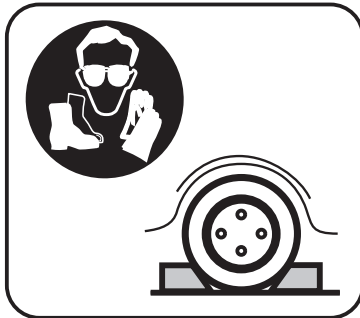

Personal protection equipment is required before operation. The unlifted wheels of the vehicle should be chocked.



Loading can not exceed maximum capacity.



No person should remain in a vehicle that is being lifted. No person should get bodily under a vehicle that is supported by a hydraulic trolley jack.

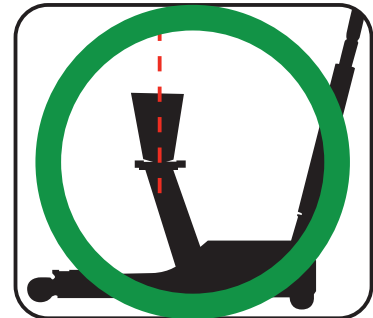
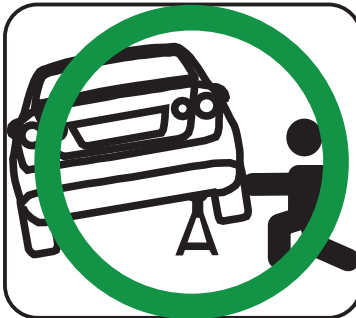

The trolley jack should be used on a hard level surface and be free to roll during lifting and lowering.



This hydraulic trolley jack should be used for lifting and lowering only; The raised vehicle should be supported on two vehicle support stands.



The load should be centrally located on the head cap.



BEFORE USE

The breather located below the hole in cross plate must be opened.

Air may become trapped in the hydraulic system during transit. To purge air:

1. Open release valve by turning handle counterclockwise.
2. Pump handle rapidly 4 full strokes. This will expel air that may have entered hydraulic fluid passages during transit.
3. Close release valve by rotating handle clockwise and pump handle.
4. Repeat this procedure or follow trouble shooting instructions provided.

OWNER/USER RESPONSIBILITY

The owner and/or user must have an understanding of the manufacturer's operating instructions and warnings before using this trolley jack. Personnel involved in the use and operation of equipment shall be careful, competent, trained, and qualified in the safe operation of the equipment and its proper use when servicing motor vehicles and their components. Warning information should be emphasized and understood. If the operator is not fluent in English, the manufacturer's instructions and warnings shall be read to and discussed with the operator in the operator's native language by the purchaser/owner, making sure that the operator comprehends its contents. Owner and/or user must study and maintain for future reference the manufacturer's instructions. Owner and/or user is responsible for keeping all warning labels and instruction manuals legible and intact. Replacement labels and literature are available from the manufacturer.

INSPECTION

Visual inspection should be made before each use of the jack, checking for leaking hydraulic fluid and damaged, loose or missing parts. Each jack must be inspected by a manufacturer's repair facility immediately, if subjected to an abnormal load or shock. Any jack which appears to be damaged in any way, is found to be badly worn, or operates abnormally **MUST BE REMOVED FROM SERVICE** until necessary repairs are made by a manufacturer's authorized repair facility. It is recommended that an annual inspection of the jack be made by a manufacturer's authorized repair facility and that any defective parts, decals or warning labels be replaced with manufacturer's specified parts.

OPERATING INSTRUCTIONS

IMPORTANT: Before attempting to raise a vehicle, check vehicle service manual for recommended lifting surfaces.

1. To raise load: Close release valve tightly (by turning handle clockwise). **DO NOT OVERTIGHTEN.** Position jack under load so that saddle will contact load firmly and load is centered so it cannot slip. Operate jack handle or depress the foot pedal until saddle approaches the load. Once again check to see that saddle is correctly positioned. Raise load to desired height. Place jack stands of appropriate capacity under the vehicle. **DO NOT CRAWL UNDER VEHICLE WHILE LIFTING VEHICLE OR PLACING OR REMOVING JACK STANDS!** Place jack stands at vehicle manufacturer's recommended lift areas that provide stable support for the raised vehicle.
2. To lower load: Open release valve **VERY SLOWLY** (by turning handle counterclockwise). When release valve is opened, saddle and load will be lowered. Lower the vehicle slowly so as not to shock load the jack stands. Once repairs are completed, raise vehicle enough to remove jack stands. Lower vehicle very slowly. **DO NOT CRAWL UNDER VEHICLE WHILE LIFTING VEHICLE OR PLACING OR REMOVING JACK STANDS!**

CAUTION: Keep hands or feet away from the hinge mechanism of the jack.

MAINTENANCE INSTRUCTIONS

IMPORTANT: When adding or replacing hydraulic fluid, always use a quality hydraulic fluid. **DO NOT** use brake fluid, alcohol, glycerine, detergent motor oil, or dirty oil as improper fluid can cause serious internal damage to jack.

To add hydraulic fluid: With saddle fully lowered and jack on level ground, remove breather. The hydraulic fluid should just cover the surface of the internal cylinder visible through the hole. Do not overfill. Replace breather. If low, add hydraulic fluid as needed.

Maintenance and Inspection: The owner and/or user must maintain and inspect the jack in accordance with the manufacturer's instructions.



**1000 KG
WORKING LOAD LIMIT**

**ULTRA LOW PROFILE PROFESSIONAL
WORKSHOP JACK**

SWJ1000ULP

LUBRICATION

All moving joints require lubrication on a regular maintenance schedule. Remove handle and grease the lower end of handle where it rotates in the handle socket. Using a grease gun, grease the lift arm pivot shaft grease fitting until grease appears at the end of the shaft. Grease all lift arm linkages, front wheels and rear castors.

PROPER STORAGE

It is recommended that the jack be stored in a dry location with all wheels touching the ground on a relatively level surface.

TROUBLESHOOTING

Important: Service jacks are self-contained devices used for lifting, but not sustaining, a partial vehicular load. In accordance with AS 2615:2016 standard, section 6.4 Loss of height under load: "The loss of height under load shall not exceed 5% of the original height of the head cap above the base plane. At the conclusion of 30 minutes, the loss of height shall not exceed 5 mm." Lowering within this range is considered normal operation and is NOT a warrantable defect.

PROBLEM					SOLUTION
Jack will not lift rated load or leaks down excessively	Jack will not lift to its full height	Jack will not lower completely	Jack will not lift smoothly or jack feels spongy	Jack will not hold rated load or handle rises	
✓					The release valve is not closed. Turn the valve clockwise tightly. If this does not work, remove handle, lubricate handle receptacle and handle end, then retry.
✓	✓				Low on hydraulic fluid. Refill the jack to the correct level of hydraulic fluid.
✓					Pump seals or back-up ring may be defective. Clean hydraulic fluid passages, replace seals and refill hydraulic fluid. (Must be serviced by qualified service center)
	✓		✓		The hydraulic system has trapped air. Open the release valve, pump handle rapidly (4) full strokes to purge air, close release valve.
		✓			Return spring is broken or linkages are binding. Replace spring if broken. Grease pivot shaft and all lift arm linkages.
				✓	Discharge ball is not sealing hydraulic system and oil may be dirty. Manually flush hydraulic system. Open the release valve, as required, to raise and lower the lift arm. Manually raise and lower lift arm.



1000 KG
WORKING LOAD LIMIT

ULTRA LOW PROFILE PROFESSIONAL
WORKSHOP JACK

SWJ1000ULP

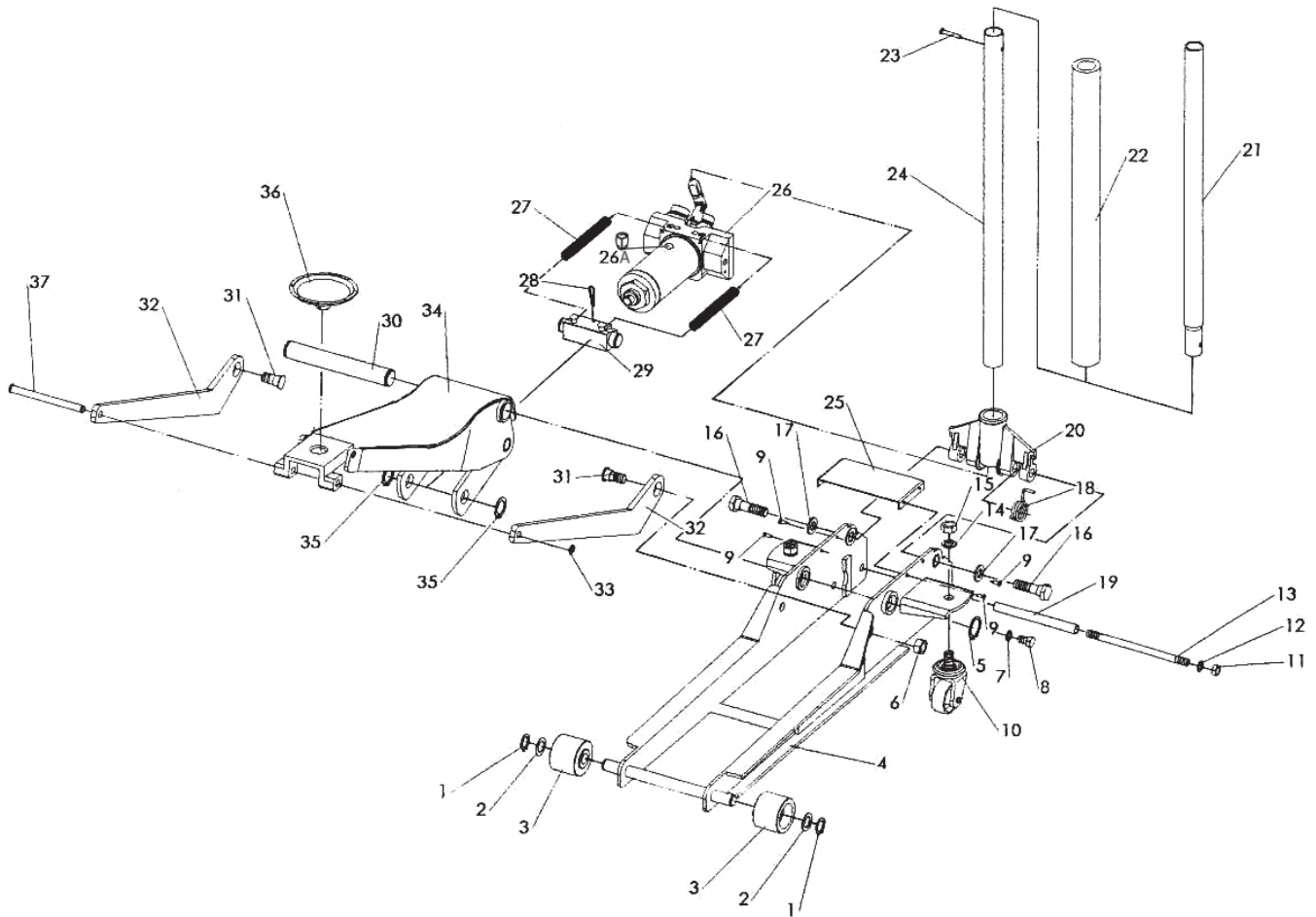

Index No.	Part No.	Description	Qty.	Index No.	Part No.	Description	Qty.
1		Retaining Ring (incl. w/#3)	2	19		Pull Rod Sheath	1
2		Washer (incl. w/#3)	2	20		Handle Socket	1
3	SWJ1000-3	Front Wheel Kit (incl. #1 & #2)	set of 2	21		Handle Upper	1
4		Side Plate	1	22	SWJ1000-22	Handle Bumper Sleeve	1
5		Washer 24	2	23		Hex Bolt M6 x 35	1
6		Hex Nut M16	2	24		Handle Lower	1
7		Spring Washer	2	25		Inspection Plate	1
8		Hex Bolt M12 x 20	2	26	SWJ1000-26	Power Unit Assembly	1
9		Screws	4	26A		Breather	1
10	SWJ1000-10	Rear Caster Wheel Kit (incl. #14 & #15)	set of 2	27		Spring	4
11		Nut M8	2	28		Split Pin 4 x 25	1
12		Washer 8	2	29		Block Linkage	1
13		Pull Rod	1	30		Shaft Arm	1
14		Spring Washer 18 (incl. w/10)	2	31		Bolt	2
15		Nut M18 (incl. w/10)	2	32		Long Linkage	2
16		Bolt	2	33		Retaining Ring	2
17		Spring Washer	2	34		Lift Arm Assembly	1
18		Torsion Spring	2	35		Retaining Ring 25	2
				36		Saddle	1
				37		Linkage Axle	1
				N/S	SWJ1000-SK	Jack Seal Kit (O-ring Type)	1